



RTM-8

ANALOG MULTIPLEXER

OPERATION AND CALIBRATION INSTRUCTIONS

CONTENTS:

1. *GENERAL DESCRIPTION*
2. *MOUNTING INSTRUCTIONS*
3. *REPLACING FUSES*
4. *ASSEMBLY*
5. *CURRENT INPUTS*
6. *CONNECTING TRANSMITTERS TO THE MULTIPLEXER*
7. *CONNECTING Pt-100 TO THE MULTIPLEXER*
8. *CONNECTING THE MULTIPLEXER TO A PLC*
9. *CONTROL*
 - 9.1 Enable
 - 9.2 Address
 - 9.3 Address Polarity
 - 9.4 Control Tables
10. *CALIBRATION*
 - 10.1 *Calibration Procedure*
 - 10.2 *Calibration Tables*
 - 10.2.1 "ZERO" - Coarse Calibration Tables
 - 10.2.2 "SPAN" - Coarse Calibration Tables
11. *MULTIDROP CONFIGURATION*
12. *SPECIFICATIONS*

1. GENERAL DESCRIPTION

The RTM-8 is a multiplexer for 16 analog inputs. The first eight channels, marked 1-8, are designated for Pt-100 sensors, while the remaining (9-16), are for 4-20mA current loop inputs.

The RTM-8 output is a 4-20mA active current loop, with a 28mA limitation.

Each Pt-100 input has its own signal conditioner which uses six DIP-switches for coarse setting and two (on panel) potentiometers for fine tuning.

2. MOUNTING INSTRUCTIONS

The RTM-8 is a standard DIN rail mounted device.

Place the unit on the upper part of the mounting rail with the fastening tab facing down. Using a suitable flat screwdriver loosen the tab slightly and attach the unit to the rail. Once the tab is loosened, ensure that the unit is fastened securely in place.

3. REPLACING FUSES

To replace a blown fuse, disassemble the unit as follows:

- a. Take off both terminal strips by removing the four screws at the edges.

Note: This does not require disconnecting the cables connected to the strips.

- b. Remove the front panel using a suitable flat screwdriver. Press down gently on the plastic spring-loaded tabs located in the slots on either side of the unit.
- c. Disconnect the flat connectors, which connect the front panel printed circuit.
- d. Replace the blown fuse.

WARNING: Never install a fuse rated more than 200mA.

4. ASSEMBLY

The RTM-8 unit includes two printed circuit cards designated as P.N 7020 and P.N 7021. The two printed circuit cards should occupy the slots in the enclosure according to fig 1.

Insert the two printed cards into their slots. Connect the flat cable between them. Connect the front panel flat cables. The panel must be inserted into the grooves on both sides of the case while pressing down until a distinct "click" is heard. Assembly is completed by laying the terminal strips in place.

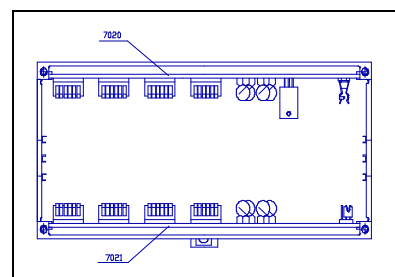

Figure 1

Note: The terminal strips are polarized and must not be placed backwards.

5. CURRENT INPUTS

The eight 4-20mA current inputs are marked as channels 9-16. **These inputs are for current only.**

The "COM" input is the return for all the current channels. It is possible to connect any current source, as long as a closed loop is maintained.

WARNING: Voltage sources are not allowed to be connected to the current inputs, as permanent damage might occur.

6. CONNECTING TRANSMITTERS TO THE MULTIPLEXER

6.1 Two-Wire Transmitter

A Two-Wire transmitter is connected so that its positive terminal is connected to the positive terminal of the power supply, and its negative terminal is connected to the "I" terminal. (see fig 2)

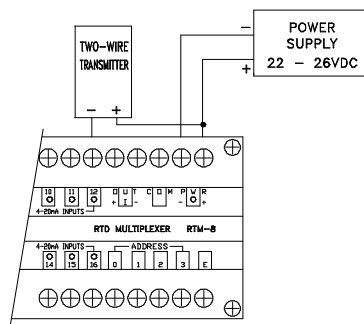

Figure 2

6.2 Four-Wire Transmitter

A Four-Wire transmitter is connected so that its positive terminal is connected to the "I" terminal, and its negative terminal is connected to the "COM" terminal. (see fig 3).

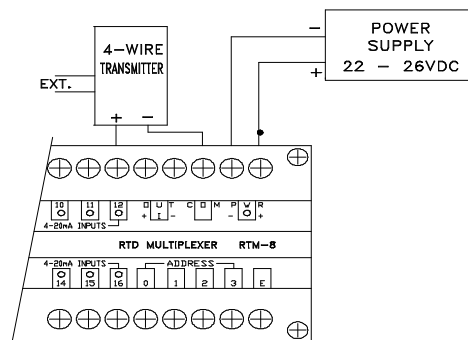

Figure 3

7. CONNECTING Pt-100 TO THE MULTIPLEXER

The Pt-100 probe should be connected according to fig 3. The three wires connecting the probe should be identical. The distance of the probe can be up to 100 meters. A shielded cable is recommended. The shield should be grounded at one point. When possible, connect the ground at the multiplexer's end.

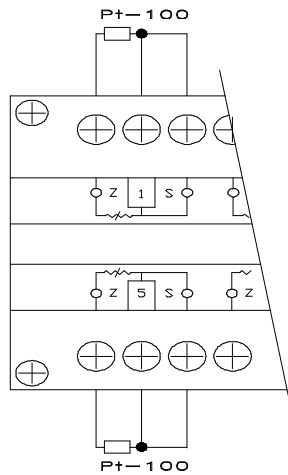

Figure 4

8. CONNECTING THE RTM-8 TO A PLC

The multiplexer's output should be connected to 4-20mA input of the PLC analog module (see fig 5). The RTM-8 multiplexer generates the output current, therefore the PLC analog module should be configured as four wire transmitter connection.

CAUTION: The PLC's configuration must be as for active current connection. **NEVER use the Two-wire connection mode**, as it connects +24Vdc to the RTM-8's +I_o terminal. This will cause a permanent failure.

9. CONTROL

The RTM-8 unit is controlled via four address lines and one E (Enable) line. The control terminals (Address and Enable), were designed to receive control signals levels up to 40V so that almost any PLC's DC output module can be used. (see fig 5)

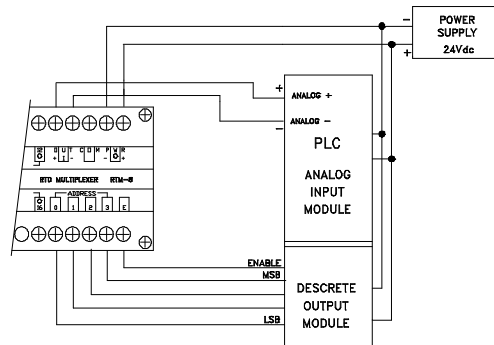

Figure 5

9.1 Enable

The unit is enabled when a logical "1" ($4V < E < 40V$) is connected to the E Terminal. In a disabled state, the RTM-8 outputs no current and reflects a "Hi-Z" state. This feature allows the connection of several RTM-8 units to a single PLC analog (4-20mA) input by tying their outputs together, connecting the address lines in parallel and selecting between them by controlling the Enable lines individually.

9.2 Address

The required channel is selected by four address lines.
The operating voltages are:

$$\begin{aligned} \text{Logical "1"} &- 5V < V_i < 40V \\ \text{Logical "0"} &- 0V < V_i < 0.5V \end{aligned}$$

9.3 Address polarity (see fig 6)

Address polarity is controlled by three internal pins and a jumper over two of them, located on PN 7021 printed circuit board, accessible behind the Enable terminal. The unit is supplied with the jumper set for "true high" control logic, i.e. "0000" selects channel #1, and "1111" selects channel #16.

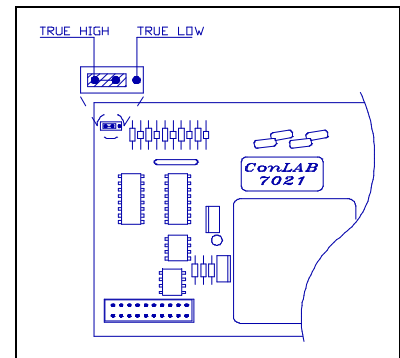

Figure 6

Moving the jumper to the second alternative reverses the logic.

Note: *If the address control lines voltages are generated from different power supply, the negative terminal should be connected to the RTM-8's "COM" terminal.*

9.4 Control Tables

9.4.1 "True Low" Setting

ADDRESS BUS A3 A2 A1 A0	E	OUTPUT CHANNEL
0 0 0 0	1	16
0 0 0 1	1	15
0 0 1 0	1	14
0 0 1 1	1	13
0 1 0 0	1	12
0 1 0 1	1	11
0 1 1 0	1	10
0 1 1 1	1	9
x x x x	0	NO OUTPUT

ADDRESS BUS A3 A2 A1 A0	E	OUTPUT CHANNEL
1 0 0 0	1	8
1 0 0 1	1	7
1 0 1 0	1	6
1 0 1 1	1	5
1 1 0 0	1	4
1 1 0 1	1	3
1 1 1 0	1	2
1 1 1 1	1	1
x x x x	0	NO OUTPUT

9.4.2 "True High" Setting

ADDRESS BUS A3 A2 A1 A0	E	OUTPUT CHANNEL
0 0 0 0	1	1
0 0 0 1	1	2
0 0 1 0	1	3
0 0 1 1	1	4
0 1 0 0	1	5
0 1 0 1	1	6
0 1 1 0	1	7
0 1 1 1	1	8
x x x x	0	NO OUTPUT

ADDRESS BUS A3 A2 A1 A0	E	OUTPUT CHANNEL
1 0 0 0	1	16
1 0 0 1	1	15
1 0 1 0	1	14
1 0 1 1	1	13
1 1 0 0	1	12
1 1 0 1	1	11
1 1 1 0	1	10
1 1 1 1	1	9
x x x x	0	NO OUTPUT

Note: *The unit includes three internal potentiometers. These potentiometers are carefully adjusted and sealed in the factory. It is not recommended to alter these calibration potentiometers.*

10. CALIBRATION

To calibrate the RTM-8s' Pt-100 channels, the limits must be defined.

Tmin is the temperature at which the output current is 4mA.

Tmax is the temperature at which the output current is 20mA.

Tspan is the difference between Tmax and Tmin.

10.1 Calibration procedure

- a. Remove the terminal strips to get access to the coarse setting switches.
- b. Set the channels DIP-switches to the desired calibration ranges according to the calibration tables.
- c. Re-install the terminal strips (the terminal strips are polarized and should be returned to their original position).
- d. Connect the unit to 24Vdc source.
- e. Connect a Pt-100 calibrator* set for T_{min} to the proper input terminals.
- f. Apply the proper channel selection (address) code by applying +24V to those that, according the table should be "1".
- g. Adjust the proper "Z" potentiometer to obtain an output current of 4.000mA.
- h. Set the calibrator for T_{max} and adjust the "S" potentiometer to obtain an output current of 20.000mA.
- i. Repeat this procedure until satisfactory results are obtained.
- j. Change the address to the next channel to be calibrated.
- k. Repeat steps b to h

* The calibrator is set according to DIN 43760 Pt-100 table ($\alpha = 0.00385$)

10.2 CALIBRATION TABLES

Note: Logic state of "0" is when the DIP-switch lever is down.

10.2.1 "ZERO" - COARSE CALIBRATION TABLES

ZERO TEMP °C	CHANNELS 1 - 4		
	SW6	SW5	SW4
-103-43	1	1	1
-47 20	0	1	1
1888	1	0	1
81.....153	0	0	1
150 220	1	1	0
215 285	0	1	0
280 352	1	0	0
350 415	0	0	0

CHANNELS 5 - 8		
SW1	SW2	SW3
1	1	1
0	1	1
1	0	1
0	0	1
1	1	0
0	1	0
1	0	0
0	0	0

10.2.2 "SPAN" - COARSE CALIBRATION TABLES

SPAN °C	CHANNELS 1 - 4		
	SW1	SW2	SW3
50 76	1	1	1
65.... 115	1	0	1
110.... 180	0	1	1
135.... 225	0	1	0
215....440	0	0	1
400.....800	0	0	0

CHANNELS 5 - 8		
SW6	SW5	SW4
1	1	1
1	0	1
0	1	1
0	1	0
0	0	1
0	0	0

11. MULTIDROP CONFIGURATION

In the disabled state ($E=0$), the multiplexer outputs no current and exhibits a "High Z" state which means than to current is output or absorbed. This mode allows the connection of several RTM-8 units to one PLC's analog input, by tying their output terminals together, connecting the address lines in parallel, and controlling individual Enable lines to select the desired multiplexer by disabling all but one (see fig 7).

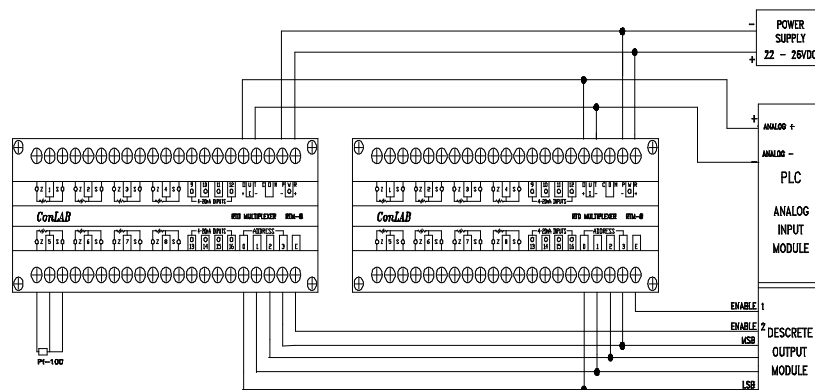

Figure 7

12. SPECIFICATIONS

<i>ANALOG INPUTS:</i>	8, Pt-100 Channels $\alpha=0.00385$ 8, 0/4-20mA Channels
<i>RTD INPUT:</i>	
Zero adjustability:	-100 to +200°C
Span adjustability:	50 to 750°C
Lead Compensation Error:	$\pm 0.025^\circ\text{C}$ for 10 Ω lead resistance
Max Lead Resistance:	120 Ω
Pt-100 linearization:	± 0.05 typ. ± 0.1 max. of span
<i>CURRENT INPUT</i>	
Max Input Current:	30 mA
Reverse Polarity Protection:	Yes
Output Accuracy (Refer to Current Input):	$\pm 0.05\%$ typ. $\pm 0.1\%$ of span max.
<i>CONTROL INPUTS:</i>	
	4 Address inputs 1 Enable input True High or True Low (User selectable)
Logic :	Low: "0" < 0.5V High: 4 < "1" < 40V
Logic Levels:	
<i>OUTPUT:</i>	4 - 20mA, Current Loop
<i>SWITCHING TIME:</i>	< 20 μSec (into resistive load)
<i>INDICATORS:</i>	1 Yellow LED, Power-On indicator 8 Red LED, 4-20mA input activity indicator
<i>SUPPLY VOLTAGE:</i>	24 $\pm 10\%$ Vdc (regulated)
<i>SUPPLY CURRENT CONSUMPTION:</i>	120 mA $\pm 10\text{mA}$
<i>FUSE:</i>	150 mA, Fast Blow
<i>TEMPERATURE STABILITY:</i>	$\pm 0.01\%$ of span/ 1°C
<i>OPERATING TEMPERATURE:</i>	0 to 60°C (32 to 140°F)
<i>STORAGE TEMPERATURE:</i>	-25 to +85°C (-13 to 185°F)
<i>HUMIDITY:</i>	0 to 95% Relative humidity, non-condensing
<i>HOUSING:</i>	Plastic Polycarbonate
Box:	According to IP50 DIN 40050
Terminals:	According to IP20 DIN 40050
<i>WEIGHT:</i>	0.9 Kg.
<i>DIMENSIONS:</i>	73Hx200Wx121Dmm (2.88"x7.88"x4.76")